

# Particle Swarm Optimization (PSO) and Ant Colony Optimization (ACO) for optimizing PID parameters on Autonomous Underwater Vehicle (AUV) control system

*by* Tony Yulianto

---

**Submission date:** 25-Dec-2020 11:21PM (UTC+0700)

**Submission ID:** 1481237756

**File name:** Paper\_6.pdf (893.2K)

**Word count:** 3851

**Character count:** 19329

PAPER <sup>1</sup> OPEN ACCESS

## Particle Swarm Optimization (PSO) and Ant Colony Optimization (ACO) for optimizing PID parameters on Autonomous Underwater Vehicle (AUV) control system

To cite this article: T Herlambang *et al* 2019 *J. Phys.: Conf. Ser.* **1211** 012039

View the [article online](#) for updates and enhancements.



**IOP ebooks™**

Bringing you innovative digital publishing with leading voices to create your essential collection of books in STEM research.

Start exploring the collection - download the first chapter of every title for free.

# Particle Swarm Optimization (PSO) and Ant Colony Optimization (ACO) for optimizing PID parameters on Autonomous Underwater Vehicle (AUV) control system

T Herlambang<sup>1</sup>, D Rahmalia<sup>2</sup>, T Yulianto<sup>3</sup>

<sup>1</sup>Information System Department, University of Nahdlatul Ulama Surabaya

<sup>2</sup>Mathematics Department, University of Islam Darul Ulum Lamongan

<sup>3</sup>University of Islam Madura

e-mail : [teguh@unusa.ac.id](mailto:teguh@unusa.ac.id), [dinitarahmalia@gmail.com](mailto:dinitarahmalia@gmail.com)

**Abstract.** Indonesia consists of seventy percents of sea such that Indonesia has much marine resource. For exploring marine resource, it is required Autonomous Underwater Vehicle (AUV) with its control. In AUV, there are surge, sway, heave position and roll, pitch, yaw angle which have to be controlled. PID (Proportional-Integral-Derivative) control has been developed in many control system problems. In previous research, the tuning of PID parameters such as  $K_p$ ,  $K_i$ , and  $K_d$  has been applied by Ziegler-Nichols technique. In this research, the optimization of PID parameters will be approached by heuristic methods such as Particle Swarm Optimization (PSO) and Ant Colony Optimization (ACO). PSO is inspired by the flock of birds or fishes in food search while ACO is inspired by the cooperative behavior of ant colonies, to find the shortest path from their nest to the food source. Either particle in PSO or path consisting pheromone in ACO represents PID parameters and the fitness function is integral of absolute error (IAE). Based on simulations, heuristic methods can result responses with small overshoot and fast rise time and settling time.

## 1 Introduction

Indonesia consists of seventy percents of sea such that Indonesia has much marine resource. For exploring marine resource, it is required Autonomous Underwater Vehicle (AUV) with its control. In AUV, there are linear motions : surge, sway, heave position, and angular rotations : roll, pitch, yaw angle. Both angle and position have to be controlled for resulting stable AUV. The controls for the AUV are rudder for controlling surge and roll, fin for controlling sway, heave, pitch, and yaw [2], [4], [5], [8].

PID (Proportional-Integral-Derivative) control has been developed in many control system problems [3], [9]. PID control works by tuning parameters proportional gain, integral gain, and derivative gain [7], [18]. In previous research, the tuning of PID parameters such as proportional gain, integral gain, and derivative gain has been applied by Ziegler-Nichols technique [18]. In this research, the optimization of PID parameters will be approached by heuristic methods [16] such as Particle Swarm Optimization (PSO) and Ant Colony Optimization (ACO). Both PSO and ACO have been applied in optimization [10], [11], [12] and control problem [13], [14].

Particle Swarm Optimization (PSO) was discovered by Kennedy and Eberhart in 1995. PSO is inspired by the behavior of flocks of birds, swarm of insects, or school of fish in which individuals are called particles and the population is called a swarm. The PSO is initialized with a group of random candidate solutions as a swarm of particles. Each particle is given initial position and velocity. When particle finds a direction to the source of food, other particles will follow them [6].

Ant Colony Optimization (ACO) is optimization method which is inspired by behavior of ant colony which can find the best path from nest to food source. This method was discovered by Dorigo in 1990. At the early time, ants start to travel from their home to food source by selecting path randomly. Before returning to their home, ants deposit pheromone on path which has visited. After returning to their home, pheromone information is updated based evaporation rate. At the optimization process, pheromone is updated until all ants choose the similar path as the best path [1].

The simulations are applied by two heuristic methods : PSO and ACO. After PSO and ACO obtain optimized PID parameters in pitch angle and heave position, the parameters will be used for creating response curve of pitch angle and heave position. From the response, we can compute rise time, peak time, maximum overshoot, settling time, and integral of absolute error (IAE) as objective function (fitness function).

## 2. Mathematical Model of AUV

In AUV, there are six degrees of freedom : surge, sway, heave, roll, pitch, and yaw. In linear motions, there are surge, sway and heave. Surge, sway, and heave are linear motions in x-axis, y-axis, and z-axis respectively. In angular rotations, there are roll, pitch and yaw. Roll, pitch, and yaw are angular rotations in x-axis, y-axis, and z-axis respectively. Model of AUV can be seen on figure 1.

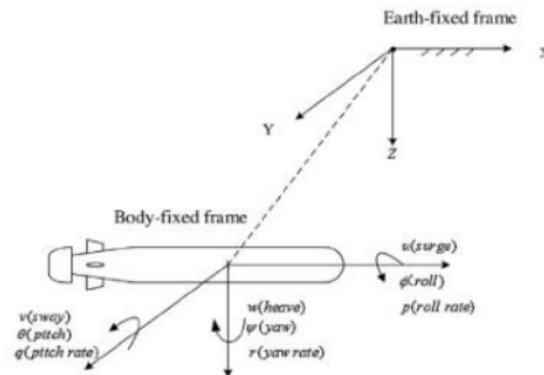


Figure 1. AUV model with six degrees of freedom

Based Newton Law, the mathematical model of AUV can be constructed as follows [17] :

$$X = m [\dot{u} - vr + wq - x_G(q^2 + r^2) + y_G(pq - \dot{r}) + z_G(pr + \dot{q})] \quad (1)$$

$$Y = m [\dot{v} + ur - wp + x_G(pq + \dot{r}) - y_G(p^2 + r^2) + z_G(qr - \dot{p})] \quad (2)$$

$$Z = m [\dot{w} - uq + vp + x_G(pr - \dot{q}) + y_G(qr + \dot{p}) - z_G(p^2 + q^2)] \quad (3)$$

$$K = I_x \dot{p} + (I_z - I_y)qr + I_{xy}(pr - \dot{q}) - I_{yz}(q^2 - r^2) - I_{xz}(pq + \dot{r}) + m(y_G(\dot{w} - uq + vp) - z_G(\dot{v} + ur - wp)) \quad (4)$$

$$M = I_y \dot{q} + (I_x - I_z)pr - I_{xy}(qr + \dot{p}) - I_{yz}(pq - \dot{r}) - I_{xz}(p^2 - r^2) - m(x_G(\dot{w} - uq + vp) - z_G(\dot{u} - vr + wq)) \quad (5)$$

$$N = I_z \dot{r} + (I_y - I_x) pq - I_{xy} (p^2 - q^2) - I_{yz} (pr + \dot{q}) + I_{xz} (qr - \dot{p}) + m(x_G(\dot{v} + ur - wp) - y_G(\dot{u} - vr + wq)) \quad (6)$$

Where the parameters are  $m$  is mass of AUV,  $I_x, I_y, I_z$  are moment of inertia at x-axis, y-axis, and z-axis respectively,  $x_G, y_G, z_G$  are longitudinal, athwart, and vertical position of center of gravity respectively. The others are :

|                    |                        |                      |
|--------------------|------------------------|----------------------|
| $X$ : surge force  | $x$ : surge position   | $u$ : surge velocity |
| $Y$ : sway force   | $y$ : sway position    | $v$ : sway velocity  |
| $Z$ : heave force  | $z$ : heave position   | $w$ : heave velocity |
| $K$ : roll moment  | $\phi$ : roll angle    | $p$ : roll rate      |
| $M$ : pitch moment | $\theta$ : pitch angle | $q$ : pitch rate     |
| $N$ : yaw moment   | $\psi$ : yaw angle     | $r$ : yaw rate       |

In this research, the problem is restricted for linear motion and angular rotation. Only equation (3) and (5) will be used. By ignoring surge, sway, roll and yaw, the variables become  $v = r = p = \phi = \psi = y = 0$ . The state variables are pitch angle  $\theta$ , pitch velocity  $q$ , heave position  $z$ , and heave velocity  $w$ .

Hydrodynamics of AUV can be explained as follows :

In pitch moment equation, consider equation (5) :

$$M = I_y \dot{q} + (I_x - I_z) pr - I_{xy} (qr + \dot{p}) - I_{yz} (pq - \dot{r}) - I_{xz} (p^2 - r^2) - m(x_G(\dot{w} - uq + vp) - z_G(\dot{u} - vr + wq))$$

By ignoring surge, sway, roll and yaw, the variables become  $v = r = p = \phi = \psi = y = 0$ . Pitch moment  $M$  can be expanded as  $M = M_q \dot{q} + M_q q + M_w \dot{w} + M_w w$ , then pitch moment equation becomes :

$$M_q \dot{q} + M_q q + M_w \dot{w} + M_w w = I_y \dot{q} - mx_G \dot{w} + mx_G uq + mz_G wq \quad (7)$$

with  $M_q$  is added mass moment of inertia due to pitch rate,  $M_w$  is added mass moment of inertia due to heave velocity,  $M_q$  is coefficient of pitch moment induced by pitch rate,  $M_w$  is coefficient of pitch moment induced by heave velocity.

The added  $(z_G W - z_B) \theta$  in right side and  $\delta$  as control unit  $M_\delta \delta$  then state equation in pitch moment becomes :

$$(M_q - I_y) \dot{q} + (M_w + mx_G) \dot{w} = (z_G W - z_B) \theta + mx_G uq + mz_G wq - M_q q - M_w w + M_\delta \delta \quad (8)$$

In heave force equation, consider equation (3) :

$$Z = m[\dot{w} - uq + vp + x_G(pr - \dot{q}) + y_G(qr + \dot{p}) - z_G(p^2 + q^2)]$$

By ignoring surge, sway, roll and yaw, the variables become  $v = r = p = \phi = \psi = y = 0$ . Heave force  $Z$  can be expanded as  $Z = Z_q \dot{q} + Z_q q + Z_w \dot{w} + Z_w w$ , then heave force equation becomes :

$$Z_q \dot{q} + Z_q q + Z_w \dot{w} + Z_w w = m \dot{w} - muq - mx_G \dot{q} - mz_G q^2 \quad (9)$$

with  $Z_{\dot{q}}$  is added mass due to pitch rate,  $Z_{\dot{w}}$  is added mass due to heave velocity,  $Z_q$  is coefficient of heave force induced by pitch rate,  $Z_w$  is coefficient of heave force induced by heave velocity.

The added fin as control unit  $Z_{\delta}\delta$  then state equation in heave force becomes :

$$(Z_{\dot{q}} + mx_G)\dot{q} + (Z_{\dot{w}} - m)\dot{w} = -muq - mz_G q^2 - Z_q q - Z_w w - Z_{\delta}\delta \quad (10)$$

From equation (8) and (10), we obtain nonlinear system and the statespace model of AUV is :

$$\dot{\theta} = q \quad (11)$$

$$(M_{\dot{q}} - I_y)\dot{q} + (M_{\dot{w}} + mx_G)\dot{w} = (z_G W - z_B)\theta + mx_G u q + mz_G w q - M_q q - M_w w + M_{\delta}\delta \quad (12)$$

$$\dot{z} = w \cos \theta - u \sin \theta \quad (13)$$

$$(Z_{\dot{q}} + mx_G)\dot{q} + (Z_{\dot{w}} - m)\dot{w} = -muq - mz_G q^2 - Z_q q - Z_w w - Z_{\delta}\delta \quad (14)$$

Using linearization  $\sin \theta \approx \theta, \cos \theta \approx 1$  and using Jacobian near equilibrium point  $(\theta^*, q^*, z^*, w^*) = (0, 0, 0, 0)$  then state space model in linear system is:

$$\begin{bmatrix} 1 & 0 & 0 & 0 \\ 0 & (M_{\dot{q}} - I_y) & 0 & (M_{\dot{w}} + mx_G) \\ 0 & 0 & 1 & 0 \\ 0 & (Z_{\dot{q}} + mx_G) & 0 & (Z_{\dot{w}} - m) \end{bmatrix} \begin{bmatrix} \dot{\theta} \\ \dot{q} \\ \dot{z} \\ \dot{w} \end{bmatrix} = \begin{bmatrix} 0 & 1 & 0 & 0 \\ (z_G W - z_B) & -(M_q - mx_G u) & 0 & -M_w \\ -u & 0 & 0 & 1 \\ 0 & -(Z_q + mu) & 0 & -Z_w \end{bmatrix} \begin{bmatrix} \theta \\ q \\ z \\ w \end{bmatrix} + \begin{bmatrix} 0 \\ -Z_{\delta} \\ M_{\delta} \\ 0 \end{bmatrix} \delta \quad (15)$$

### 3. PID Control

The PID control was patented in 1939 by Albert Callender and Allan Stevenson [9]. PID controller has been applied in many control problems. PID control works by tuning parameters  $K_p, K_i, K_d$ , where  $K_p$  is proportional gain,  $K_i$  is integral gain, and  $K_d$  is derivative gain.

#### 3.1. Close Loop Transfer Function

The block diagram of closed loop transfer function can be seen on figure 2 with  $R(s)$  is reference,  $E(s)$  is error,  $Y(s)$  is output,  $K(s)$  is controller, and  $G(s)$  is plant. In PID, we can develop  $K(s) = K_p + \frac{K_i}{s} + K_d s$  with  $K_p$  is proportional gain,  $K_i = \frac{K_p}{T_i}$  is integral gain, and  $K_d = K_p T_d$  is derivative gain [1], [4].

Based on block diagram, the closed loop transfer function is :

$$\frac{Y(s)}{R(s)} = \frac{K(s)G(s)}{1 + K(s)G(s)} \quad (16)$$

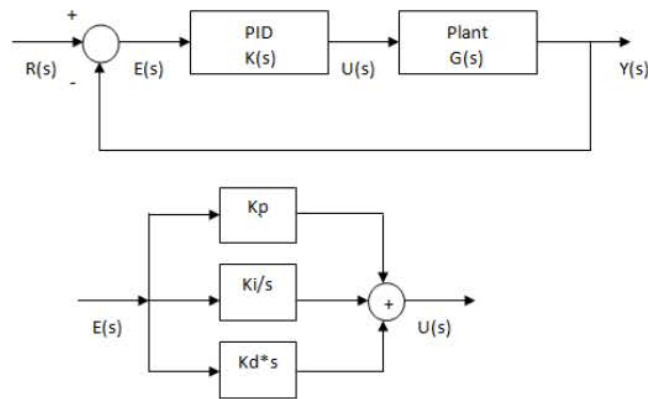


Figure 2. Close Loop Transfer Function

### 3.2. Close Loop PID Algorithm

Using parameters  $K_p$ ,  $K_i$ ,  $K_d$ , the close loop PID algorithm for computing Integral of Absolute Error (IAE) with given plant is as follows [7] :

1. Given plant in equation (17) and equation (18) as system output :

$$\dot{x} = Ax + Bu \tag{17}$$

$$y = Cx \tag{18}$$

2. Form transfer function  $G(s) = C(sI - A)^{-1}B$
3. Form closed loop transfer function

$$\frac{Y(s)}{R(s)} = \frac{K(s)G(s)}{1 + K(s)G(s)}, \text{ with } K(s) = K_p + \frac{K_i}{s} + K_d s \tag{19}$$

with PID parameters are :  $K_p$  is proportional gain,  $K_i = \frac{K_p}{T_i}$  is integral gain, and  $K_d = K_p T_d$  is derivative gain.

4. Compute  $Y(s)$  with unit step response  $R(s) = \frac{1}{s}$
5. Determine response  $y(t)$  using inverse Laplace transform  $y(t) = L^{-1}(Y(s))$
6. Compute error signal  $e(t) = r(t) - y(t) = 1 - y(t)$
7. IAE (Integral of Absolute Error) can be computed numerically

$$\int_0^T |e(t)| dt = h \sum_{i=0}^T |e(i)| \tag{20}$$

### 3.3. Characteristic of Response

The transient response of a practical control system often exhibits damped oscillations before reaching steady state [7]. The response curve  $y(t)$  to a unit step input, has characteristic as follows :

Rise time  $t_r$  : the time required for the response to rise to 100% of its final value.

Peak time  $t_p$  : the time required for the response to reach the first peak of the overshoot.

Maximum overshoot  $M_p$  : the maximum peak value of the response curve measured from unity. Maximum percent overshoot can be computed from equation (21).

$$\text{Maximum percent overshoot} = \frac{y(t_p) - y(\infty)}{y(\infty)} \times 100\% \quad (21)$$

Settling time  $t_s$  : the time required for the response curve to reach and stay within a range about the final value of size specified by absolute percentage of the final value (usually 2% or 5%)

## 4. Heuristic Method

In heuristic method, the optimization problem is finding PID parameters :  $K_p$ ,  $K_i$ ,  $K_d$  minimizing Integral of Absolute Error (IAE) as objective function (fitness function). The optimization of PID parameters will be approached by heuristic methods such as Particle Swarm Optimization (PSO) and Ant Colony Optimization (ACO). PSO is inspired by the flock of birds or fishes in food search while ACO is inspired by the cooperative behavior of ant colonies, to find the shortest path from their nest to the food source. Either particle in PSO or path consisting pheromone in ACO represents PID parameters with the fitness function is integral of absolute error (IAE).

### 4.1. Particle Swarm Optimization (PSO)

PSO algorithm can be constructed as follows [15] :

1. Based on Routh-Hurwitz stability, generate initialization particle position  $x^k(0)$ ,  $k = 1, 2, \dots, \text{max\_swarm}$
2. Generate initialization particle velocity  $v^k(0)$ ,  $k = 1, 2, \dots, \text{max\_swarm}$
3. Set local best particle  $p^k = x^k(0)$ ,  $k = 1, 2, \dots, \text{max\_swarm}$
4. Set global best particle  $g = \arg \min_p (f(p^k))$ ,  $k = 1, 2, \dots, \text{max\_swarm}$
5. Update particle along time  $t$ .

for  $t = 0 : \text{max\_t}$

for  $k = 1 : \text{max\_swarm}$

- Calculate the particle velocity  $v^k(t+1)$

$$v^k(t+1) = wv^k(t) + c_1r_1(p^k - x^k(t)) + c_2r_2(g - x^k(t)) \quad (22)$$

- Update the particle position  $x^k(t+1)$

$$x^k(t+1) = x^k(t) + v^k(t+1) \quad (23)$$

- Calculate the fitness of particle  $f(x^k(t+1))$

- Update local best particle  $p_{ij}^k$

$$p^k = \arg \min_x (f(x^k(0)), f(x^k(1)), \dots, f(x^k(t)), f(x^k(t+1))) \quad (24)$$



```

end
Update global best particle  $g_{ij}$ 

$$g = \arg \min_p (f(p^k), k = 1, 2, \dots, \max\_swarm) \tag{25}$$

end

```

4.2. Ant Colony Optimization (ACO)

ACO algorithm can be constructed as follows [15] :

1. Set the number of ants  $N$  and the pheromone decay factor  $\rho$ .
2. Generate max pop feasible solutions based on Routh-Hurwitz stability, and give the probability in equation (27) based on fitness in equation (26).

$$fitness_k = \frac{1}{(f(X^k)+1)}, \quad k = 1, 2, \dots, \max pop \tag{26}$$

$$p(X^k) = \frac{fitness_k}{\sum_{k=1}^{\max pop} fitness_k}, \quad k = 1, 2, \dots, \max pop \tag{27}$$

3. Calculate cumulative probability range  $C_i$
4. Generate random variable  $r_s \sim U(0,1)$   $s = 1, 2, \dots, N$ .
5. Determine selected variable  $X^k, k \in \{1, 2, \dots, \max pop\}$  and for every ant  $s$ .
6. Calculate objective function  $f(X^k)$  for every ant  $s$ .
7. Choose minimum fitness function  $f_{best} = \min(f(X^k), k \in \{1, 2, \dots, \max pop\})$ , and count  $N_{best}$ , the number of  $f_{best}$
8. Set constant  $Q$  and calculate  $\sum \Delta\tau(X^k), k = 1, 2, \dots, \max pop$

$$\sum \Delta\tau(X^k) = \begin{cases} N_{best} \cdot \frac{Q}{f_{best}}, & \text{if } X^k \text{ is the best variable} \\ 0, & \text{otherwise} \end{cases} \tag{28}$$

9. Update the pheromone based on equation (29)
- $$\tau_k = (1 - \rho)\tau_k + \sum \Delta\tau(X^k), \quad k = 1, 2, \dots, \max pop \tag{29}$$

10. Update the pheromone probability based on equation (30)
- $$p(X^k) = \frac{\tau_k}{\sum \tau_k}, \quad k = 1, 2, \dots, \max pop \tag{30}$$

11. Repeat step 3-10 until all ants choose the best path consisting pheromone and process converges.

5. Results

State space model used in PID simulations as in equation (31) and (32) :

$$\begin{bmatrix} \dot{\theta} \\ \dot{w} \\ \dot{q} \\ \dot{z} \end{bmatrix} = \begin{bmatrix} 0 & 0 & 1 & 0 \\ 0.0175 & -1.273 & -3.559 & 0 \\ -0.052 & 1.273 & -2.661 & 0 \\ -5 & 1 & 0 & 0 \end{bmatrix} \begin{bmatrix} \theta \\ w \\ q \\ z \end{bmatrix} + \begin{bmatrix} 0 \\ 0.085 \\ 21.79 \\ 0 \end{bmatrix} \delta \tag{31}$$

$$\begin{bmatrix} y_1 \\ y_2 \end{bmatrix} = \begin{bmatrix} 1 & 0 & 0 & 0 \\ 0 & 0 & 0 & 1 \end{bmatrix} \begin{bmatrix} \theta \\ w \\ q \\ z \end{bmatrix} \tag{32}$$

The simulations are applied by two heuristic methods : PSO and ACO. After PSO and ACO obtain optimized PID parameters in pitch angle and heave position, the parameters will be used for creating response curve of pitch angle and heave position. Optimal response curve has minimum IAE signed by fast settling time and rise time, and minimum overshoot.

5.1. PSO Simulation

Parameters used in PSO simulation are : the number of population is 5 and maximum iteration as stopping criteria is 31. Optimization process of PSO can be seen figure 3 and figure 4. Figure 3 shows optimization process of PSO on pitch angle and optimal IAE is resulted by PID parameters :  $K_p = 1.896, K_i = 1.773, K_d = 0.637$ . Figure 4 shows optimization process of PSO on heave position and optimal IAE is resulted by PID parameters :  $K_p = -0,603, K_i = -1,561, K_d = -1,339$ .

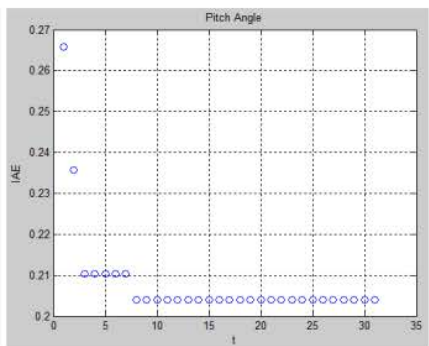


Figure 3. Optimization process of PSO on pitch angle

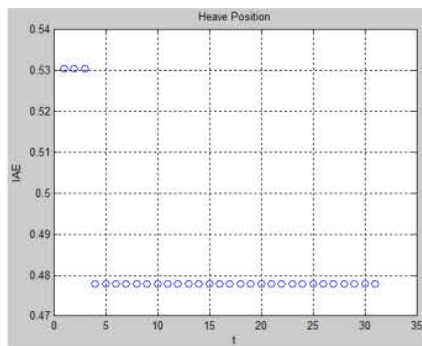
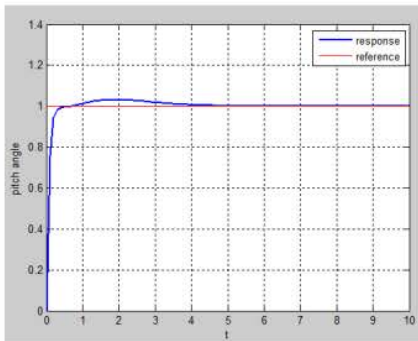
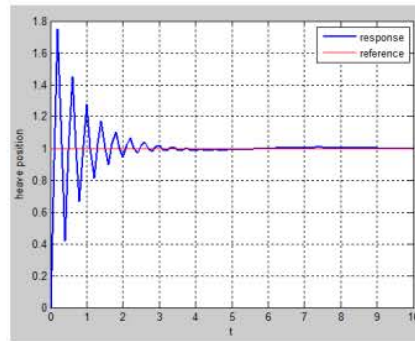


Figure 4. Optimization process of PSO on heave position

PID parameters will be applied in response curve. Figure 5 shows pitch angle response curve with optimized PID parameters from PSO with rise time is 0.6, peak time is 1.9, maximum overshoot is 0.0317, and settling time is 0.3. Figure 6 shows heave position response curve with optimized PID parameters from PSO with rise time is 0.1, peak time is 0.2, maximum overshoot is 0.7513, and settling time is 2.3.



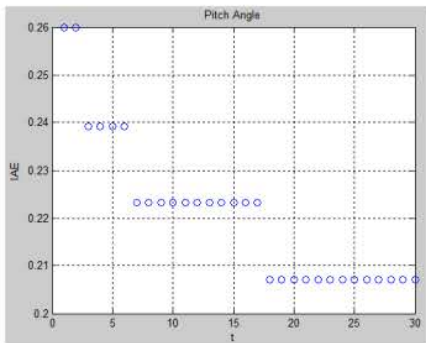
**Figure 5.** Pitch angle response curve with optimized PID parameters from PSO



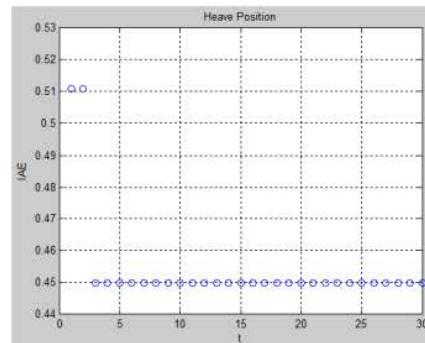
**Figure 6.** Heave position response curve with optimized PID parameters from PSO

5.2. ACO Simulation

Parameters used in ACO simulation are : the number of population is 100, the number of ant is 5, pheromone decay factor is 0.01 and maximum iteration as stopping criteria is 30. Optimization process of ACO can be seen figure 7 and figure 8. Figure 7 shows optimization process of ACO on pitch angle and optimal IAE is resulted by PID parameters :  $K_p = 1.918, K_i = 1.872, K_d = 0.970$ . Figure 8 shows optimization process of ACO on heave position and optimal IAE is resulted by PID parameters :  $K_p = -0,181, K_i = -0.214, K_d = -1,323$ .

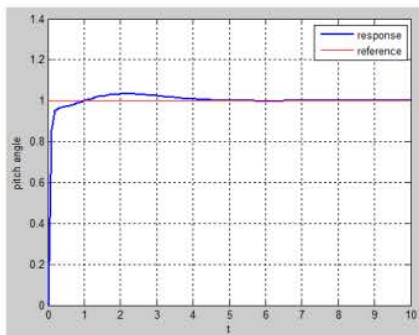


**Figure 7.** Optimization process of ACO on pitch angle

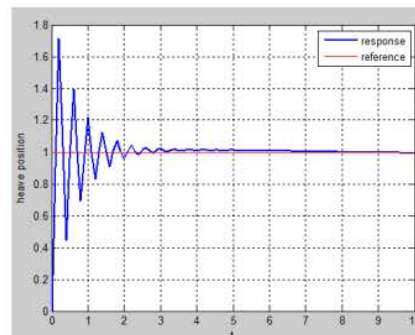


**Figure 8.** Optimization process of ACO on pitch angle

PID parameters will be applied in response curve. Figure 9 shows pitch angle response curve with optimized PID parameters from ACO with rise time is 1.0, peak time is 2.1, maximum overshoot is 0.0328, and settling time is 0.2. Figure 10 shows heave position response curve with optimized PID parameters from ACO with rise time is 0.1, peak time is 0.2, maximum overshoot is 0.7134, and settling time is 1.9.



**Figure 9.** Pitch angle response curve with optimized PID parameters from ACO



**Figure 10.** Pitch angle response curve with optimized PID parameters from ACO

## 6. Conclusion

In PID model, Integral of Absolute Error (IAE) as objective function is determined by  $K_p$ ,  $K_i$ ,  $K_d$  and generally, they are determined by trial and error so that optimization process is required. PID parameters can be approached by heuristic methods: PSO and ACO. From the simulation, PSO and ACO can optimize PID parameters and result response curve. From the response curve, we can compute rise time, peak time, maximum overshoot, settling time, and integral of absolute error (IAE) as objective function (fitness function). The best IAE has characteristic: fast settling time and rise time, and minimum overshoot. Developments of this research are optimizing PID parameters for other linear motions: surge and sway and other angular rotations: roll and yaw to result more complex AUV control system.

## Acknowledgement

Author would like to thank for suggestions and comments for this research.

## References

- [1] Dorigo M and Stutzle T 2004 *Ant Colony Optimization*. (London: The MIT Press)
- [2] Ermayanti E, Aprilini E, Nurhadi H and Herlambang T 2015 Estimate and Control Position Autonomous Underwater Vehicle Based on Determined Trajectory using Fuzzy Kalman Filter Method *International Conference on Advance Mechatronics, Intelligent Manufacture, and Industrial Automation (ICAMIMIA)-IEEE Surabaya Indonesia, 15 – 16 October 2015*.
- [3] Herlambang T, Subchan and Nurhadi H 2018 Design of UNUSAITs AUV Motion Control Using Sliding PID (SPID) *Proc. of Design of UNUSAITs AUV Motion Control Using Sliding PID (SPID), IEEE, ICETASIA 2018, Surakarta, Indonesia, Sep 06 – 07*.
- [4] Herlambang T, Djatmiko E B and Nurhadi H 2015 Navigation and Guidance Control System of AUV with Trajectory Estimation of Linear Modelling *Proc. of International Conference on Advance Mechatronics, Intelligent Manufacture, and Industrial Automation, IEEE, ICAMIMIA 2015, Surabaya, Indonesia, pp. 184-187, Oct 15 – 17*.
- [5] Herlambang T, Djatmiko E B and Nurhadi H 2015 Ensemble Kalman Filter with a Square Root Scheme (EnKF-SR) for Trajectory Estimation of AUV SEGOROGENI ITS *International Review of Mechanical Engineering IREME Journal, Vol. 9, No. 6. Pp. 553-560, ISSN 1970 – 8734. Nov*.
- [6] Kennedy J and Eberhart R C 1995 Particle Swarm Optimization *Proceedings IEEE Int. Conf. Neural Network* pp. 1942-1948.

- [7] Ogata K 2002 *Modern Control Engineering* (New Jersey: Prentice Hall)
- [8] Oktafianto K, Herlambang T, Mardijah and Nurhadi H 2015 Design of Autonomous Underwater Vehicle Motion Control Using Sliding Mode Control Method *International Conference on Advance Mechatronics, Intelligent Manufacture, and Industrial Automation (ICAMIMIA) IEEE Surabaya Indonesia, 15 – 16 Oktober 2015*.
- [9] Pillai RP, Jadhav SP and Patil MD 2013 Tuning of PID Controllers using Advanced Genetic Algorithm *International Conference & Workshop on Advanced Computing*.
- [10] Rahmalia D 2018 Estimation of Exponential Smoothing Parameter on Pesticide Characteristic Forecast using Ant Colony Optimization (ACO) *Eksakta : Jurnal Ilmu-Ilmu MIPA* Vol. 18 No. 1 pp. 56–63.
- [11] Rahmalia D 2018 Teknik Penalti pada Optimisasi Berkendala Menggunakan Particle Swarm Optimization *JMPM* Vol. 3 No. 1 pp. 44-52.
- [12] Rahmalia D 2017 Particle Swarm Optimization-Genetic Algorithm (PSOGA) on Linear Transportation Problem *International Conference on Mathematics : Pure, Applied and Computation-2016 AIP Conference Proceedings* Vol. 1867, pp. (020030)1-12.
- [13] Rahmalia D and Herlambang T 2017 Application Ant Colony Optimization on Weight Selection of Optimal Control SEIR Epidemic Model *Proceeding The 7<sup>th</sup> Annual Basic Science International Conference*. pp. 196-199.
- [14] Rahmalia D and Herlambang T 2018 Weight Optimization of Optimal Control Influenza Model Using Artificial Bee Colony *International Journal of Computing Science and Applied Mathematics* Vol. 4 pp. 27-31.
- [15] Rao SS 2009 *Engineering Optimization Theory and Practice* (New Jersey : John Wiley and Sons)
- [16] Rathore A and Kumar M 2015 Robust PID Tuning of Autonomous Underwater Vehicle Using Harmonic Search Algorithm Based on Model Order Reduction *International Journal of Swarm Intelligence and Evolutionary Computation* Vol. 5 pp. 1-6.
- [17] Syahroni N and Choi J W 2012 An Autonomous Underwater Vehicle Simulation Using Linear Quadratic Servo Based on Open Control Platform *Modelling and Simulation in Engineering*. Hindawi Publishing Corporation, Vol. 2012 pp. (291318) 1-4.
- [18] Xue D, Chen Y and Atherton DP 2007 *Linear Feedback Control* ( Society for Industrial and Applied Mathematics)

# Particle Swarm Optimization (PSO) and Ant Colony Optimization (ACO) for optimizing PID parameters on Autonomous Underwater Vehicle (AUV) control system

## ORIGINALITY REPORT

20%

SIMILARITY INDEX

23%

INTERNET SOURCES

22%

PUBLICATIONS

11%

STUDENT PAPERS

## PRIMARY SOURCES

1

[iopscience.iop.org](http://iopscience.iop.org)

Internet Source

6%

2

[www.researchgate.net](http://www.researchgate.net)

Internet Source

6%

3

[article.nadiapub.com](http://article.nadiapub.com)

Internet Source

3%

4

[media.neliti.com](http://media.neliti.com)

Internet Source

3%

5

Nanang Syahroni, Young Bong Seo, Jae Weon Choi. "Depth Control of Autonomous Underwater Vehicle Based on Open Control Platform", IFAC Proceedings Volumes, 2008

Publication

2%

Exclude quotes On

Exclude matches < 2%

Exclude bibliography On